

Article number: 12307200080110

Description: KLEE-coil 307 200 080.110

M8 Hardened/zinc-plated steel with hexagon

Measures

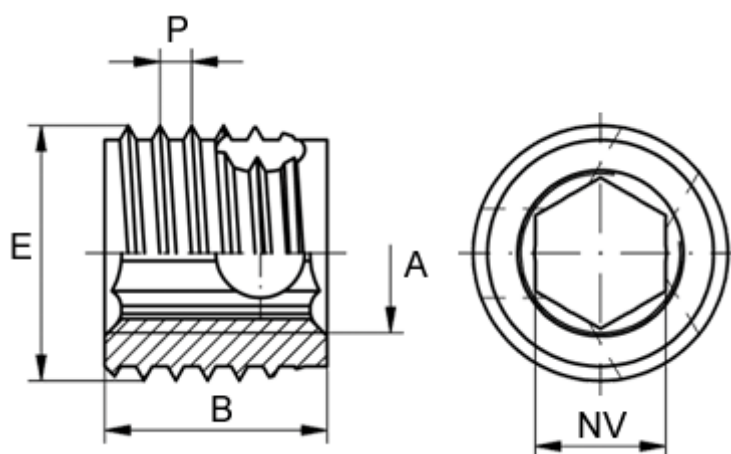

Female thread A	= M8
Length B	= 9
Male thread E	= 12
Min hole depth blind hole	= 12
Min material thickness	= 9
sw	= -
Thread pitch P	= 1.5
Type	= 307 200 080 ...